



All-in-One PC

User Manual

ET232 Series

ET2321I

ET2322I

E9051
Revised Edition V2
March 2014

COPYRIGHT INFORMATION

No part of this manual, including the products and software described in it, may be reproduced, transmitted, transcribed, stored in a retrieval system, or translated into any language in any form or by any means, except documentation kept by the purchaser for backup purposes, without the express written permission of ASUSTeK COMPUTER INC. ("ASUS").

ASUS PROVIDES THIS MANUAL "AS IS" WITHOUT WARRANTY OF ANY KIND, EITHER EXPRESS OR IMPLIED, INCLUDING BUT NOT LIMITED TO THE IMPLIED WARRANTIES OR CONDITIONS OF MERCHANTABILITY OR FITNESS FOR A PARTICULAR PURPOSE. IN NO EVENT SHALL ASUS, ITS DIRECTORS, OFFICERS, EMPLOYEES OR AGENTS BE LIABLE FOR ANY INDIRECT, SPECIAL, INCIDENTAL, OR CONSEQUENTIAL DAMAGES (INCLUDING DAMAGES FOR LOSS OF PROFITS, LOSS OF BUSINESS, LOSS OF USE OR DATA, INTERRUPTION OF BUSINESS AND THE LIKE), EVEN IF ASUS HAS BEEN ADVISED OF THE POSSIBILITY OF SUCH DAMAGES ARISING FROM ANY DEFECT OR ERROR IN THIS MANUAL OR PRODUCT.

Products and corporate names appearing in this manual may or may not be registered trademarks or copyrights of their respective companies, and are used only for identification or explanation and to the owners' benefit, without intent to infringe.

SPECIFICATIONS AND INFORMATION CONTAINED IN THIS MANUAL ARE FURNISHED FOR INFORMATIONAL USE ONLY, AND ARE SUBJECT TO CHANGE AT ANY TIME WITHOUT NOTICE, AND SHOULD NOT BE CONSTRUED AS A COMMITMENT BY ASUS. ASUS ASSUMES NO RESPONSIBILITY OR LIABILITY FOR ANY ERRORS OR INACCURACIES THAT MAY APPEAR IN THIS MANUAL, INCLUDING THE PRODUCTS AND SOFTWARE DESCRIBED IN IT.

Copyright © 2014 ASUSTeK COMPUTER INC. All Rights Reserved.

LIMITATION OF LIABILITY

Circumstances may arise where because of a default on ASUS' part or other liability, you are entitled to recover damages from ASUS. In each such instance, regardless of the basis on which you are entitled to claim damages from ASUS, ASUS is liable for no more than damages for bodily injury (including death) and damage to real property and tangible personal property; or any other actual and direct damages resulted from omission or failure of performing legal duties under this Warranty Statement, up to the listed contract price of each product.

ASUS will only be responsible for or indemnify you for loss, damages or claims based in contract, tort or infringement under this Warranty Statement.

This limit also applies to ASUS' suppliers and its reseller. It is the maximum for which ASUS, its suppliers, and your reseller are collectively responsible.

UNDER NO CIRCUMSTANCES IS ASUS LIABLE FOR ANY OF THE FOLLOWING: (1) THIRD-PARTY CLAIMS AGAINST YOU FOR DAMAGES; (2) LOSS OF, OR DAMAGE TO, YOUR RECORDS OR DATA; OR (3) SPECIAL, INCIDENTAL, OR INDIRECT DAMAGES OR FOR ANY ECONOMIC CONSEQUENTIAL DAMAGES (INCLUDING LOST PROFITS OR SAVINGS), EVEN IF ASUS, ITS SUPPLIERS OR YOUR RESELLER IS INFORMED OF THEIR POSSIBILITY.

SERVICE AND SUPPORT

Visit our multi-language web site at <http://support.asus.com>

Table of Contents

About this manual	5
Conventions used in this manual	6
Icons	6
Typography.....	6
Safety information	7
Setting up your system.....	7
Care during use	7
Sound Pressure Warning.....	8
TV Tuner (on selected models)	8
Adapter.....	8
DC Fan Warning.....	8
Package contents	9
Chapter 1: Hardware Setup	
Getting to know your All-in-One PC.....	10
Front view.....	10
Rear view	12
Bottom view (without the stand).....	14
Right side view	16
Chapter 2: Using your All-in-One PC	
Assembling the base of your All-in-One PC.....	17
Positioning your All-in-One PC.....	17
Setting up your All-in-One PC	18
Connecting a wired keyboard and mouse.....	18
Connecting a wireless keyboard and mouse	18
Powering on your All-in-One PC	19
Using the On Screen Display (OSD) Menu.....	20
Using touch screen panel gestures on Windows® 8.1.....	22
Setting up a secondary display via the HDMI-output port.....	25
Chapter 3: Working with Windows® 8.1	
Starting for the first time	27
Windows® 8.1 lock screen	27

Table of Contents

Windows® UI.....	28
Start screen.....	28
Windows® apps.....	28
Hotspots.....	29
Start button.....	31
Customizing your Start screen.....	33
Working with Windows® apps.....	34
Launching apps.....	34
Customizing apps.....	34
Accessing All Apps.....	35
Charms bar.....	37
Snap feature.....	39
Other keyboard shortcuts.....	40
Turning off your All-in-One PC.....	41
Putting your ASUS All-in-One PC on sleep mode.....	41
Chapter 4: Connecting to the Internet	
Setting up a Wi-Fi connection in Windows® 8.1.....	42
Wired connection.....	44
Setting up a Bluetooth Wireless Connection.....	45
Chapter 5: Recovering your system	
Entering the BIOS Setup.....	47
Quickly enter the BIOS.....	47
Recovering your system.....	48
Resetting your PC.....	48
Recovering from a system image file.....	49
Removing everything and reinstalling Windows.....	50
Appendices	
Notices.....	51

About this manual

This manual provides information about the hardware and software features of your All-in-One PC.

Chapter 1: Hardware Setup

This chapter details the hardware components of your All-in-One PC.

Chapter 2: Using your All-in-One PC

This chapter provides you with information on using your All-in-One PC.

Chapter 3: Working with Windows® 8.1

This chapter provides an overview of using Windows® 8.1 in your All-in-One PC.

Chapter 4: Connecting to the Internet

This chapter provides information on connecting your All-in-One PC to a wired or Wi-Fi network.

Chapter 5: Recovering your system

This chapter provides recovery options for your All-in-One PC.

Appendices

This section includes notices and safety statements for your All-in-One PC.

Conventions used in this manual

To highlight key information in this manual, some text are presented as follows:

IMPORTANT! This message contains vital information that must be followed to complete a task.

NOTE: This message contains additional information and tips that can help complete tasks.

WARNING! This message contains important information that must be followed to keep you safe while performing tasks and prevent damage to your All-in-One PC's data and components.

Icons

The icons below indicate the devices you can use for completing a series of tasks or procedures on your All-in-One PC.



Use the touchscreen.



Use the keyboard.

Typography

Bold This indicates a menu or an item that must be selected.

Italic This indicates sections that you can refer to in this manual.

All illustrations and screenshots in this manual are for reference only. Actual product specifications and software screen images may vary with location. Visit the ASUS website at www.asus.com for the latest information.

Safety information

Your All-in-One PC is designed and tested to meet the latest standards of safety for information technology equipment. However, to ensure your safety, it is important that you read the following safety instructions.

Setting up your system

- Read and follow all instructions in the documentation before you operate your system.
- Do not use this product near water or a heated source such as a radiator.
- Set up the system on a stable surface.
- Openings on the chassis are for ventilation. Do not block or cover these openings. Ensure that you leave plenty of space around the system for ventilation. Never insert objects of any kind into the ventilation openings.
- Use this product in environments with ambient temperatures between 0°C and 40°C.
- If you use an extension cord, ensure that the total ampere rating of the devices plugged into the extension cord does not exceed its ampere rating.

Care during use

- Do not walk on the power cord or allow anything to rest on it.
- Do not spill water or any other liquids on your system.
- When the system is turned off, a small amount of electrical current still remains in the product. Always unplug all power, modem, and network cables from the power outlets before cleaning the system.
- The touch screen requires periodic cleaning to perform at optimal touch sensitivity. Keep the screen clean from foreign objects or excessive dust accumulation. To clean the screen:
 - Turn off the system and disconnect the power cord from the wall.
 - Spray a small amount of household glass cleaner on the supplied cleaning cloth and gently wipe the surface of the screen.
 - Do not spray the cleaner directly on the screen.
 - Do not use an abrasive cleaner or a coarse cloth when cleaning the screen.
- If you encounter the following technical problems with the product, unplug the power cord and contact a qualified service technician or your retailer.
 - The power cord or plug is damaged.
 - Liquid has been spilled into the system.
 - The system does not function properly even if you follow the operating instructions.
 - The system was dropped or the cabinet is damaged.
 - The system performance changes.

Sound Pressure Warning

Excessive sound pressure from earphones or headphones can cause hearing loss or permanent damage to hearing. Increasing the volume and equalizer beyond default levels increases the output voltage and sound pressure produced by the earphones or headphones.

TV Tuner (on selected models)

Note to CATV System Installer—This reminder is provided to call the CATV systems installer's attention to Section 820-93 of the National Electric Code, which provides guidelines for proper grounding and, in particular, specify that the Coaxial cable shield be connected to the grounding system of the building as close to the point of cable entry as practical.

Adapter

1. Adapter specifications

- Input voltage: 100–240Vac

- Input frequency: 50–60Hz

- Rating output current: 90W (19V, 4.74A)











- Rating output voltage: 19Vdc

2. It is recommended that the power socket is in close proximity to the All-in-One PC.

DC Fan Warning

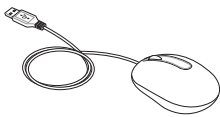
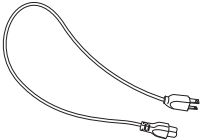
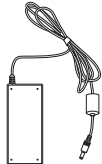
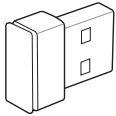
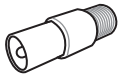
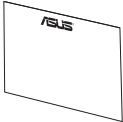
Please note that the DC fan is a moving part and can cause harm when used improperly. Keep away from the fan when using the product.

Package contents

 <p>ET2321</p>		 <p>ET2322</p>		 <p>ET2321</p>  <p>ET2322</p> 	
All-in-One PC ET232 Series, stand, and screw					
					
Wired/wireless keyboard (Optional)			Wired/wireless mouse (Optional)		
					
Power cord		AC adapter		KBM USB receiver dongle (Optional)	
					
TV connector (Optional)		Warranty Card			
					
Subwoofer (Optional)		Quick Start Guide			
				Remote Control (Optional)	

NOTE: The keyboard, mouse, AC adapter, remote control, and KBM USB receiver dongle illustrations are for reference only. Actual product specifications may vary according to location.

Chapter 1: Hardware Setup

Getting to know your All-in-One PC

Front view

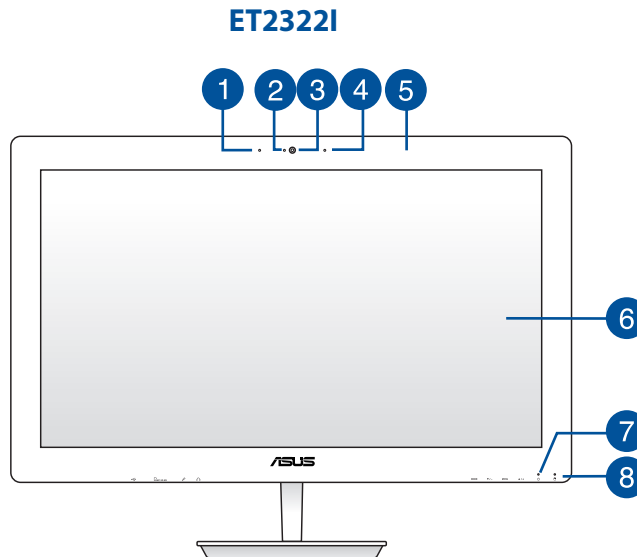
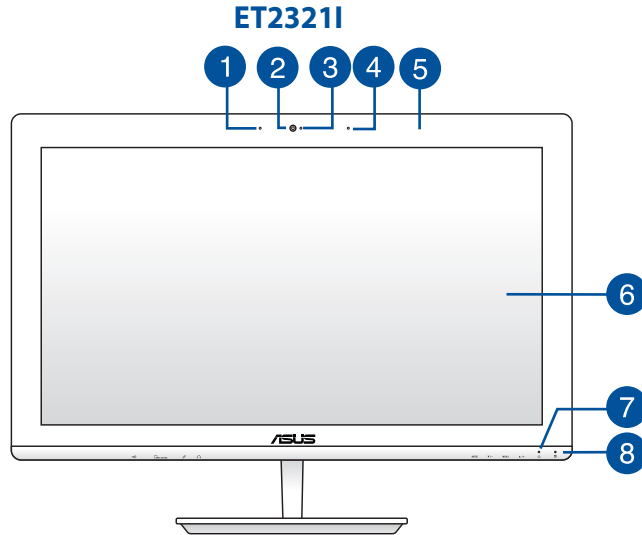

- 1 Digital microphone (Built-in)**

This built-in digital microphone can be used for video conferencing, voice narrations, audio recordings, and multimedia applications.
- 2 Webcam**

The built-in webcam with the built-in digital microphone allows you to start video chats online.
- 3 Webcam LED**

Indicates that the built-in webcam is enabled.
- 4 Digital microphone (on selected models)**

This digital microphone can be used for video conferencing, voice narrations, audio recordings, and multimedia applications.

NOTES:

- This digital microphone is available on selected models only.
- On selected models, Beam Forming is supported.

- 5 Remote control receiver**

The remote control receiver receives the infrared signal from the remote control.

NOTE: The remote control receiver is available for models with the optional TV Tuner card.

- 6 LCD display**

The 23-inch LCD display features 16:9 widescreen IPS and full HD 1920 x 1080 resolution. Touch-enabled models support 10-point capacitive touch.
- 7 Power LED**

Indicates power is on your All-in-One PC.
- 8 HDD LED**

Indicates hard drive activity.

Rear view

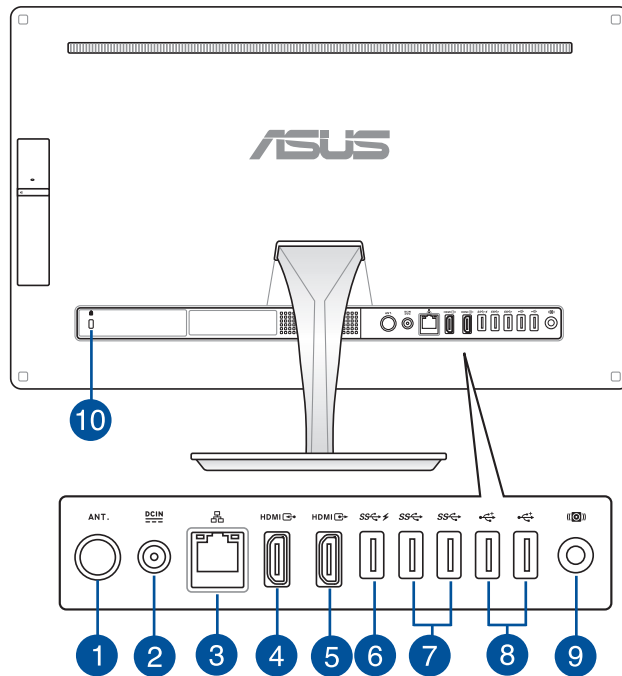

1 Antenna socket (on selected models)

Connect standard indoor or outdoor male antenna connectors to receive over-the-air broadcast TV signals.

NOTE: The antenna socket is available for models with the optional TV Tuner card.

2 Power input

The supplied power adapter converts AC power to DC power for use with this jack. To prevent damage to the PC, always use the supplied power adapter.

WARNING! The power adapter may get warm or hot when in use. Do not cover the adapter and keep it away from your body.

3 LAN port

This 8-pin RJ-45 LAN port supports a standard Ethernet cable for connection to a local network.

4 HDMI Input Port

When using the HDMI-in mode, use the HDMI Input port for receiving video/audio signals from another source such as a set-top-box or DVD player.

5 HDMI Output Port

Connect this port with devices equipped with an HDMI input port, such as an LCD monitor or projector.

6 USB 3.0 port with Ai Charger II

This USB 3.0 (Universal Serial Bus 3.0) ports provide a transfer rate of up to 5 Gbit/s and are backward compatible to USB 2.0.

This port also comes with the Ai Charger II function that allows you to quick-charge compatible devices. To enable the Ai Charger II on your All-in-One PC, go to **ASUS Manager > Power > Ai Charger II**. Select **Enable** then click **Apply**.

NOTE: To access **ASUS Manager**, double-click the **ASUS Manager** icon on the desktop task bar.

7 USB 3.0 ports

These USB 3.0 (Universal Serial Bus 3.0) ports provide a transfer rate of up to 5 Gbit/s and are backward compatible to USB 2.0.

8 USB 2.0 ports

This USB (Universal Serial Bus) port is compatible with USB 2.0 or USB 1.1 devices such as keyboards, pointing devices, flash disk drives, external HDDs, speakers, cameras and printers.

9 Subwoofer jack (on selected models)

The proprietary subwoofer jack is used to connect to the ASUS All-in-One PC subwoofer. The subwoofer allows you to enjoy vibrant bass (low frequency) sounds in your multimedia applications.

IMPORTANT! The subwoofer jack can ONLY be connected to All-in-One PC subwoofers or sound devices by ASUS. DO NOT connect other devices to this jack. Doing so may damage the device.

10 Kensington® security slot

The Kensington® security lock allows you to secure your PC using Kensington® compatible PC security products.

Bottom view (without the stand)

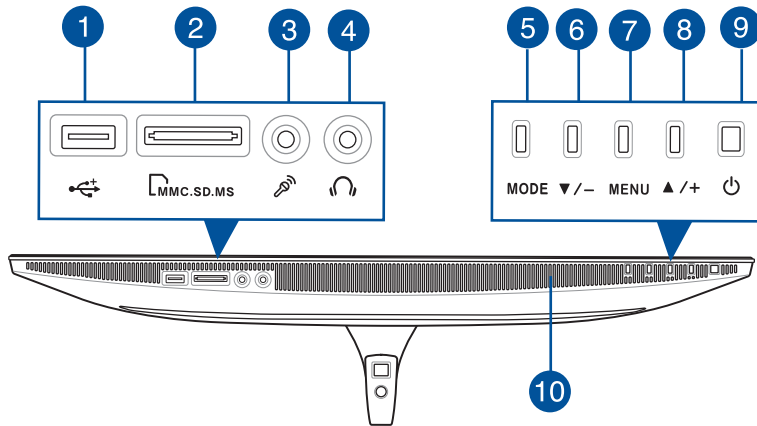

- 1 USB 2.0 port**
This USB (Universal Serial Bus) port is compatible with USB 2.0 or USB 1.1 devices such as keyboards, pointing devices, flash disk drives, external HDDs, speakers, cameras, and printers.
- 2 6-in-1 Memory card reader**
This All-in-One PC has a built-in memory card reader slot that supports MMC, SD, SDHC, SDXC, MS, MS PRO cards.
- 3 Microphone jack**
The microphone jack is designed to connect to a microphone used for video conferencing, voice narrations, or simple audio recordings.
- 4 Headphone output**
This combo jack supports speakers and headphones.
- 5 Mode button**
Touch to switch the display signal source. When switched to HDMI-in, the All-in-One PC can be used as a standard desktop LCD monitor.

- 6 Menu down button**

When adjusting the menu settings, press this button to move down to the menu selections. You can also use this button to decrease the value of selected menu items such as brightness, contrast, volume, etc.
- 7 MENU button**

Press to display the menu. Press this button to enter/select the highlighted icon (function) while the OSD is activated.
- 8 Menu up button**

When adjusting the menu settings, press this button to move up to the menu selections. You can also use this button to increase the value of selected menu items such as brightness, contrast, volume, etc.
- 9 Power button**

Press this button to turn on your All-in-One PC.
- 10 Audio speakers**

The built-in audio speaker allows you to hear audio straight from the All-in-One PC. The audio features of this All-in-One PC are software-controlled.

Right side view

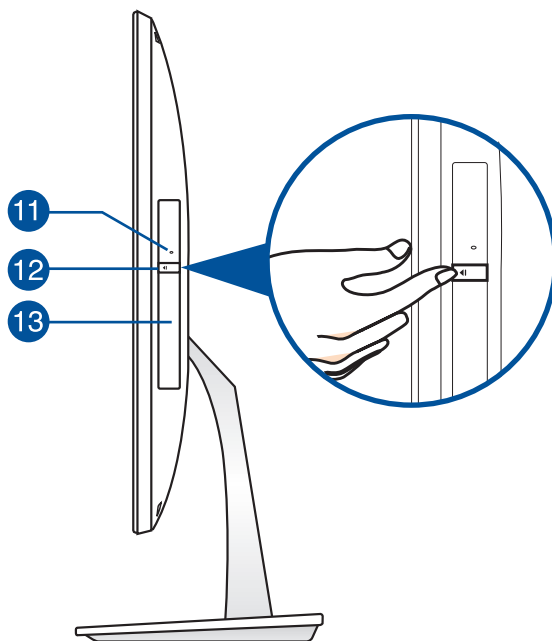

11 Optical Disc Drive manual eject hole

The manual eject hole is used to eject the drive tray in case the electronic eject button does not work.

WARNING! Use the manual eject hole only when the electronic eject button does not work.

12 Optical Disk Drive electronic eject button

Press this button to eject the optical drive tray.

You can also eject the drive tray using your media player or by right-clicking the optical drive icon in Windows File Explorer and clicking Eject.

13 Optical Drive

The built-in optical drive may support compact discs (CD), digital video discs (DVD), and/or Blu-ray discs (BD), and recordable (R) or re-writable (RW) discs. Consult product specifications for details on included optical drive.

Chapter 2: Using your All-in-One PC

Assembling the base of your All-in-One PC

1. Place the All-in-One PC on a flat and stable surface such as a table or desk.
2. Align and attach the base to the stand. Ensure that the stand is fitted firmly and aligned properly to the base.

NOTE: The stand fits to the base in one orientation only.

3. Secure the base to the stand with the bundled screw using a Phillips or a flat screwdriver. You can also use a coin or token.

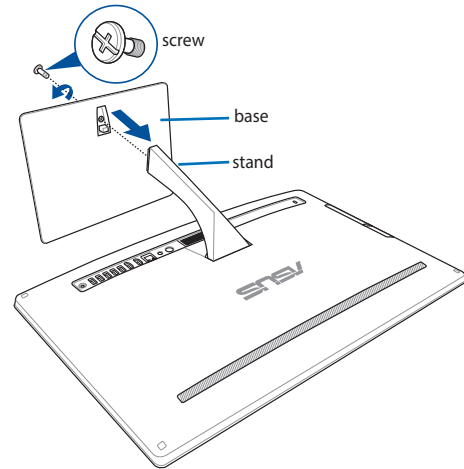

NOTE: The illustration above are for reference only. The actual base of your AiO may vary depending on the model but the installation steps remains the same.

Positioning your All-in-One PC

1. Place your All-in-One PC on a flat surface such as a table or desk.
2. Tilt the display to an angle between -5° to 25° .

IMPORTANT! Avoid adjusting the display to an angle beyond the recommended values or you may risk damaging the All-in-One PC.

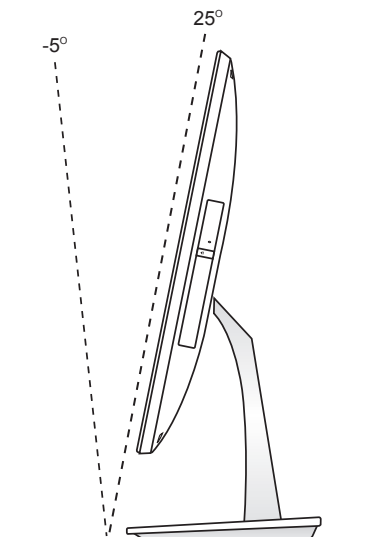

Setting up your All-in-One PC

Connecting a wired keyboard and mouse

Connect the keyboard and the mouse to the USB ports on the rear panel.

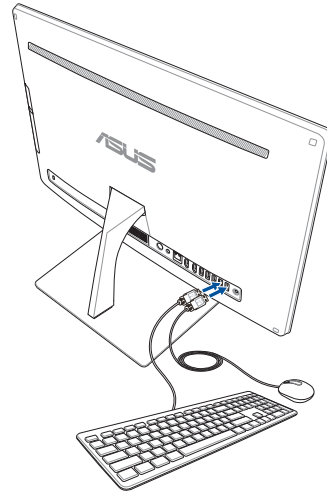

Connecting a wireless keyboard and mouse

1. Install batteries into the wireless keyboard and mouse.
2. Connect the wireless dongle for keyboard and mouse to a USB port.
3. You can begin using the wireless keyboard and mouse.

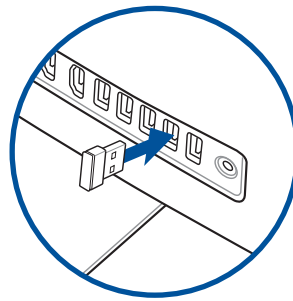

NOTES:

- Reconnect the wireless keyboard and mouse with the wireless dongle if they lose connection. Avoid using either devices alongside other wireless devices. Position the mouse and keyboard at least 20 cm away from other wireless hardware to avoid interference.
 - The illustrations above are for reference only. Actual hardware and specifications of the optional wired or wireless keyboard and mouse vary.
-

Powering on your All-in-One PC

Connect the supplied AC adapter to the **DC IN** jack on the rear panel (1, 2, and 3) and then press the **Power button** on the front panel (4) of the All-in-One PC to power on the system.

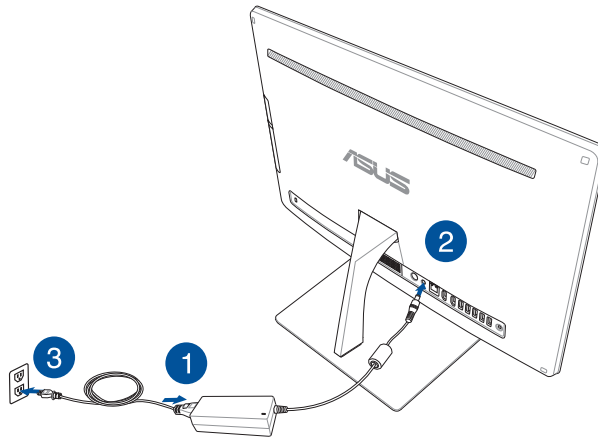

WARNING! DO NOT connect the AC power cord to an AC outlet prior to connecting the DC plug to the system. Doing so may damage the AC-DC adapter.

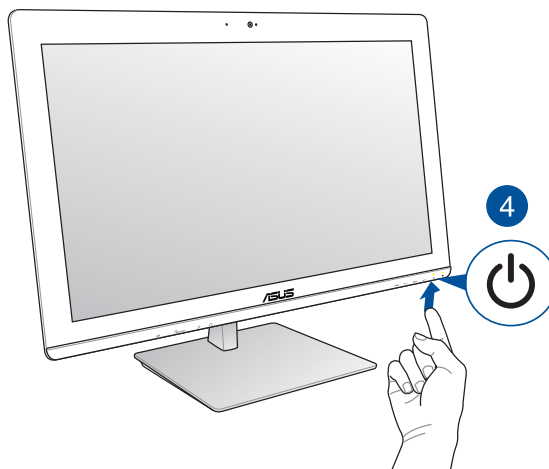

NOTE: For details on turning off your All-in-One PC, refer to the section **Turning off your All-in-One PC** in **Working with Windows® 8.1**.

Using the On Screen Display (OSD) Menu

The On Screen Display (OSD) menu will display when you:

1. Press the **Menu** button on the front panel.
2. Connect an HDMI cable to the rear HDMI input port.

Using the OSD Menu

To display the OSD menu, press the **Menu** button on the front panel. To navigate through the OSD functions or modify OSD settings, press the **Menu Up** or **Menu Down** keys on the front panel. To activate the selected function, press the **Menu** button again.

NOTE: Refer to the section **Getting to know your All-in-One PC** for the location of the front panel buttons.

Panel Off

Press this button to switch off the display.

Color

- **Brightness:** This setting can be adjusted using values between 0 to 100.
- **Contrast:** This setting can be adjusted using values between 0 to 100.
- **Color Temp. :** Four color modes are available - Cool, Normal, Warm, and User mode.

Image

- **Sharpness:** This setting can be adjusted using values between 0 to 100.
- **Aspect Control:** Select the aspect ratio to "Full" or "OverScan". This setting is available only when you use the All-in-One PC as a standard desktop LCD monitor.
- **Auto Adjust:** Adjusts the horizontal position (H-Position) and the vertical position (V-Position) of the display. This feature is available only when you use the All-in-One PC as a standard desktop LCD monitor.

Input Select

- **PC:** Displays video produced by the All-in-One PC.
- **HDMI:** Display video input from the HDMI Input port.

System Setup

- **OSD Setup:**
 1. H-Position - Adjusts the horizontal position of the OSD menu.
 2. V-Position - Adjusts the vertical position of the OSD menu.
 3. OSD Timeout - Sets the display duration of OSD menu from 10 to 120 seconds.
 4. DDC/CI - Enables or disables the DDC/CI (Display Data Channel/Command Interface).
- **Information:** Displays resolution and refresh rate.
- **Language:** Sets the OSD language.
- **All Reset:** Resets all OSD settings to defaults.

Exit

Exit from the OSD menu.

Using touch screen panel gestures on Windows® 8.1

The gestures allow you to launch programs and access the settings of your ASUS All-in-One PC. The functions can be activated by using the hand gestures to your ASUS All-in-One PC's display panel.

Left edge swipe



Swipe from the left edge of the screen to shuffle your running apps.

Right edge swipe



Swipe from the right edge of the screen to launch the Charms bar.

Top edge swipe



- In the Start screen, swipe from the top edge of the screen to view the **Customize** bar.
- In a running app, swipe from the top edge of the screen to view its menu.

Finger slide

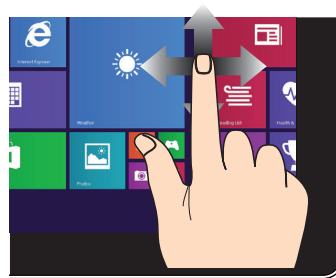

Slide your finger to scroll up and down and slide your finger to pan the screen left or right.

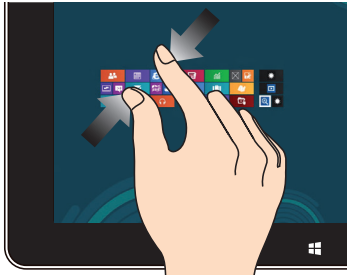
Zoom in

Bring together your two fingers on the touch panel.

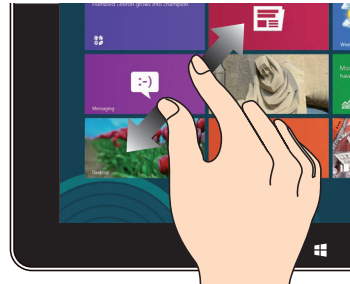
Zoom out

Spread apart your two fingers on the touch panel.

Tap/Double tap

- Tap an app to launch it.
- On Desktop mode, double-tap an item to launch it.

Tap/click and hold

- To move an app, tap and hold the app tile and drag it to a new location.
- To close an app, tap and hold the top side of the running app and drag it down to the bottom of the screen to close it.

Swipe up



Swipe up from the Start screen to launch the Apps screen.

Swipe down



Swipe down from the Apps screen to return to the Start screen.

Setting up a secondary display via the HDMI-output port

If you want to use a high-definition TV as an audio output device, connect it to the Home Theater PC and follow the steps below to configure the audio settings.

To configure the audio output via an HDMI device:

1. From the Start screen, click **Desktop** to launch the Desktop Mode.

NOTE: For more details, refer to the section *Start screen* under *Using Windows® 8.1*.

2. Right-click the Volume Mixer icon on the Windows® taskbar and click **Playback devices**.



3. From the Playback screen, select **Digital Audio (HDMI)**.
4. Click **Configure** and the Speaker Setup window pops up.

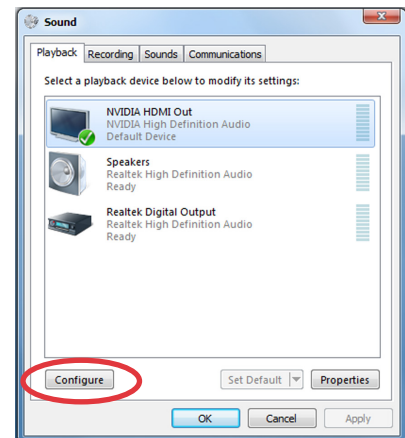

5. Select **Stereo** and click **Next**.

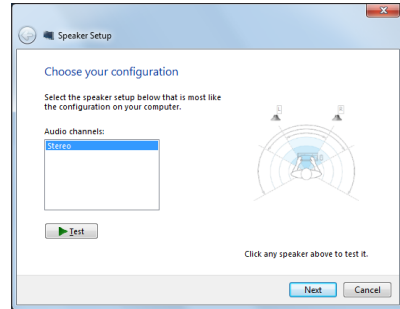

6. Tick the **Front left and right** option, and click **Next**.

7. Click **Finish** to exit the speaker setup.

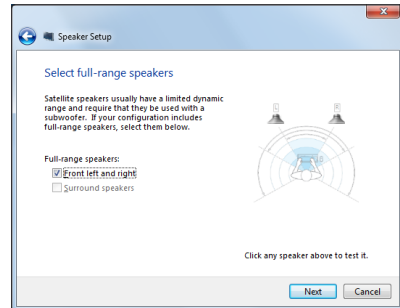

Chapter 3: Working with Windows® 8.1

Starting for the first time

When you start your computer for the first time, a series of screens appear to guide you in configuring the basic settings of your Windows® 8.1 operating system.

To start for the first time:

1. Press the power button on your ASUS All-in-One PC. Wait for a few minutes until the setup screen appears.
2. Pick a language to use on your ASUS All-in-One PC.
3. Carefully read the License Terms. Tick **I accept these license terms for Windows and this PC** then click **Accept**.
4. Follow the onscreen instructions to configure the following basic items:
 - Personalize
 - Wireless
 - Settings
 - Sign in
5. After configuring the basic items, the Windows® 8.1 tutorial appears. Watch this to learn more about Windows® 8.1 functionalities.

Windows® 8.1 lock screen

The Windows® 8.1 lock screen may appear when your ASUS All-in-One PC enters the Windows® 8.1 operating system. To proceed, tap/click on the lock screen or press any key on your ASUS All-in-One PC's keyboard.

Windows® UI

The Windows® User Interface (UI) is the tile-based display used in Windows® 8.1. It includes the following features you can use while working on your ASUS All-in-One PC.

Start screen

The Start screen appears after successfully signing in to your user account. It helps organize all the programs and applications you need in just one place.

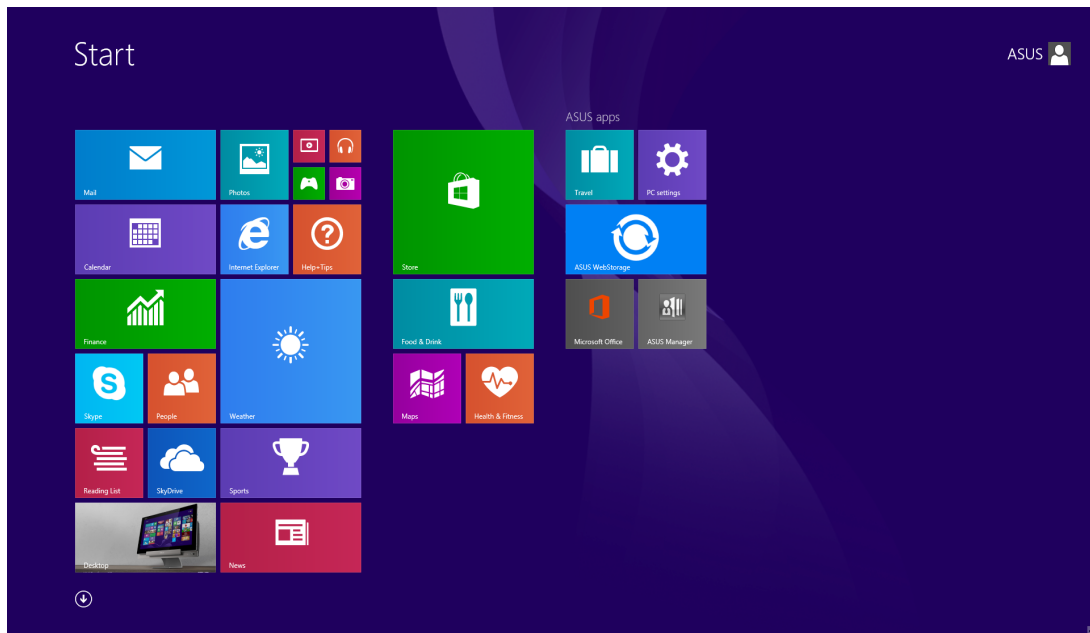

Windows® apps

These are apps pinned on the Start screen and displayed on tiled-format for easy access.

NOTE: Some apps require signing in to your Microsoft account before they are fully launched.

Hotspots

Onscreen hotspots allow you to launch programs and access your ASUS All-in-One PC settings. The functions in these hotspots can be activated using your mouse.

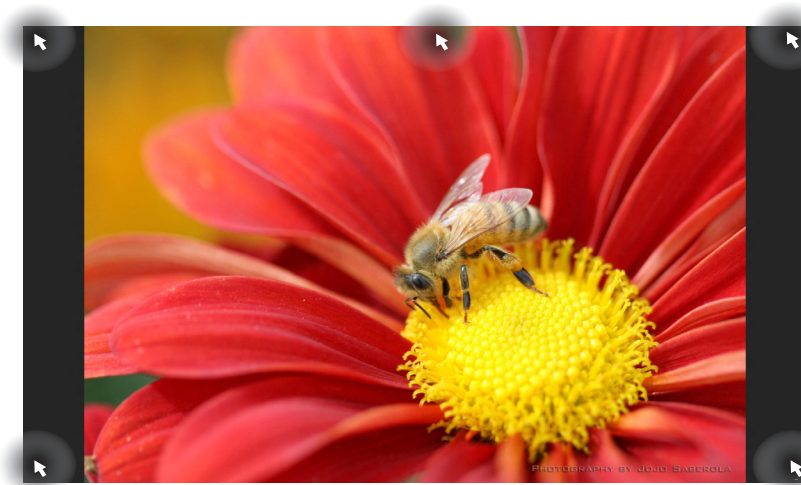

Hotspots on a running app

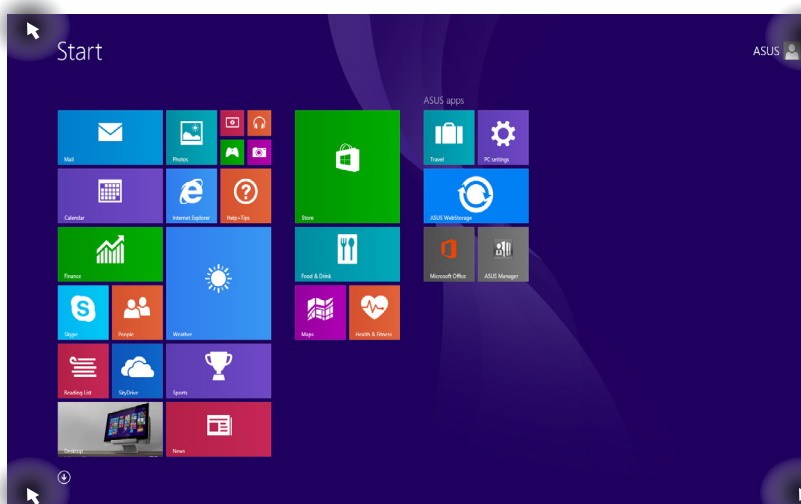

Hotspots on the Start screen



NOTE: Refer to the next page for the Hotspots' functions.

Hotspot	Action
upper left corner	Hover your mouse pointer then tap/click on the recent app's thumbnail to revert back to that running app.
	If you launched more than one app, slide down to show all running apps.
lower left corner	<p>From a running app screen:</p> <p>Hover your mouse pointer on the lower left corner then tap/click  to go back to the Start screen.</p> <hr/> <p>NOTE: You can also press  on your keyboard to go back to the Start screen.</p> <hr/> <p>From the Start screen:</p> <p>Hover your mouse pointer on the lower left corner then tap/click  to go back to that app.</p>
top	<p>Hover your mouse pointer until it changes to a hand icon. Drag then drop the app to a new location.</p> <hr/> <p>NOTE: This hotspot function only works on a running app or when you want to use the Snap feature. For more details, refer to <i>Snap feature</i> under <i>Working with Windows® apps</i>.</p> <hr/>
upper and lower right corner	Hover your mouse pointer to launch the charms bar.

Start button

Windows® 8.1 features the Start button that allows you to switch between the two most recent apps that you opened. The Start button may be accessed from the Start screen, while on Desktop mode, and on any app that is currently open onscreen.

Start button on the Start screen

NOTE: The actual color of your Start button varies depending on the display settings you chose for your Start screen.

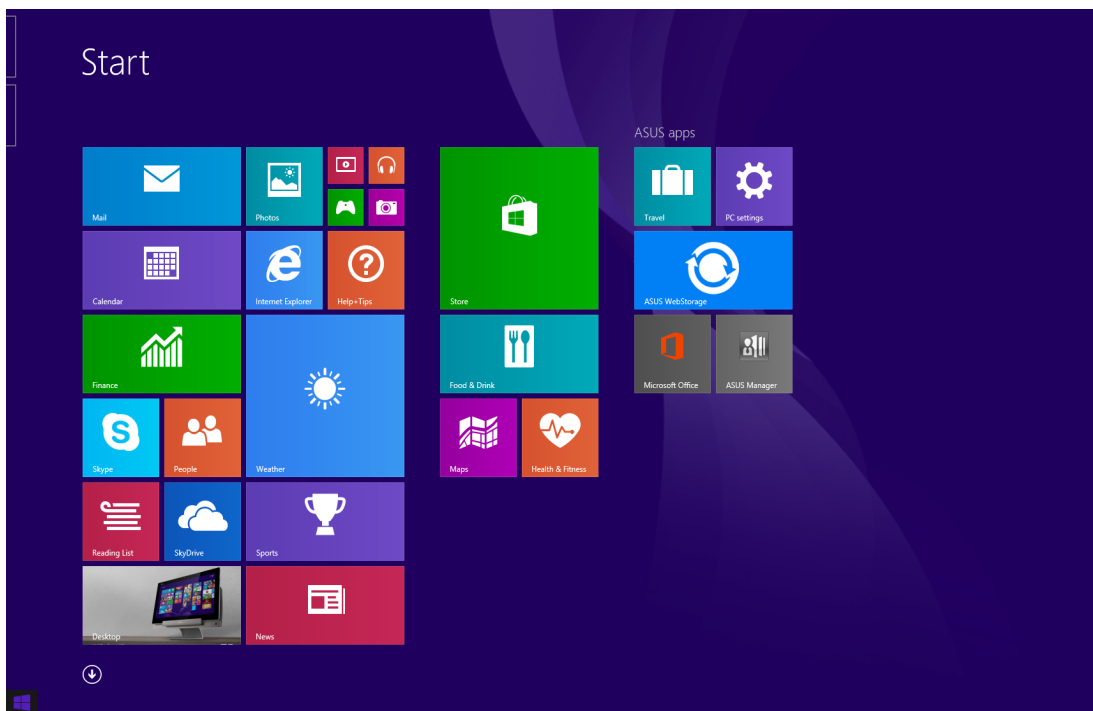

Hover your mouse pointer over the left corner of your Start screen or any opened app to call out the Start button.

Start button on Desktop mode

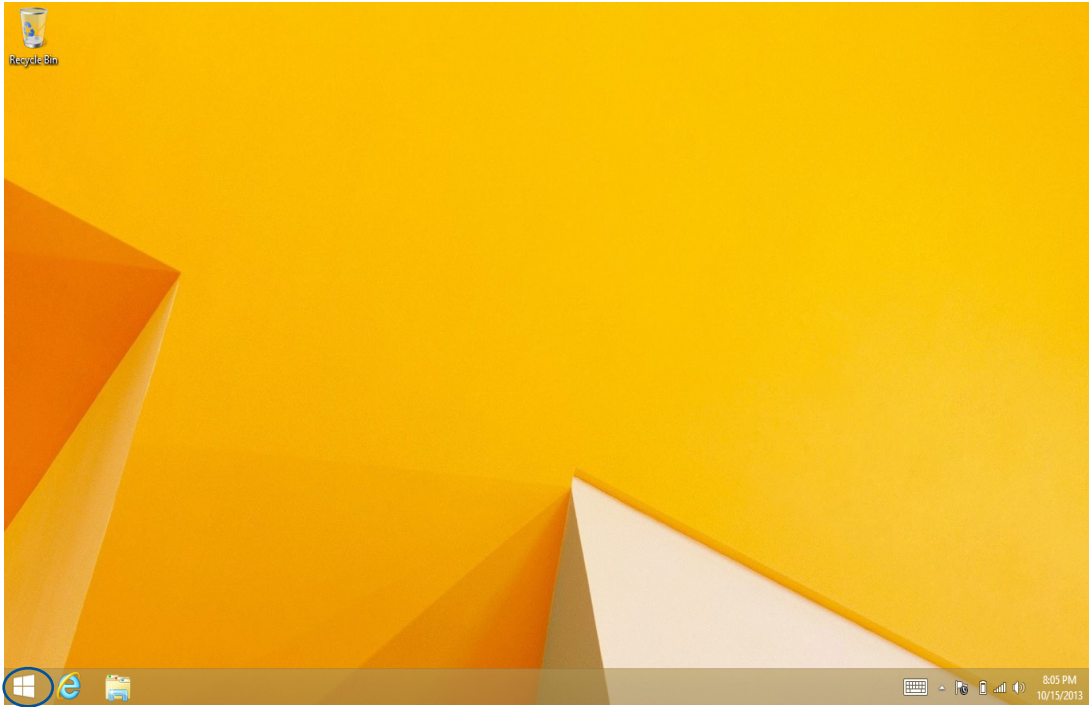

Context menu

The context menu appears as a box filled with quick access to some of the programs inside Windows® 8.1 when you right-click on the Start button.

The context menu also includes the following shut down options for your ASUS All-in-One PC: sign out, sleep, shut down, restart.

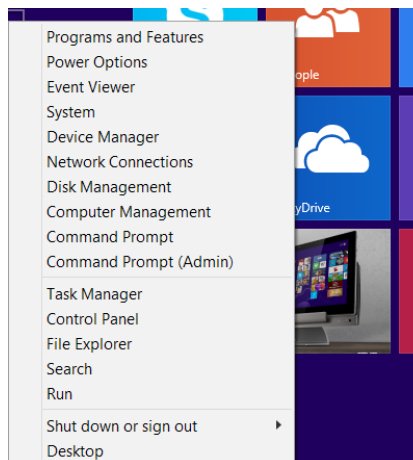

Customizing your Start screen

Windows® 8.1 also enables you to customize your Start screen, allowing you to boot directly to the Desktop mode and customize the arrangement of your apps onscreen.

To customize the settings of your Start screen:

1. Launch the Desktop.
2. Right-click anywhere on the taskbar, except on the Start button, to launch the pop-up window.
3. Click **Properties** then select the **Navigation** tab to tick the Navigation and Start screen options you want to use.

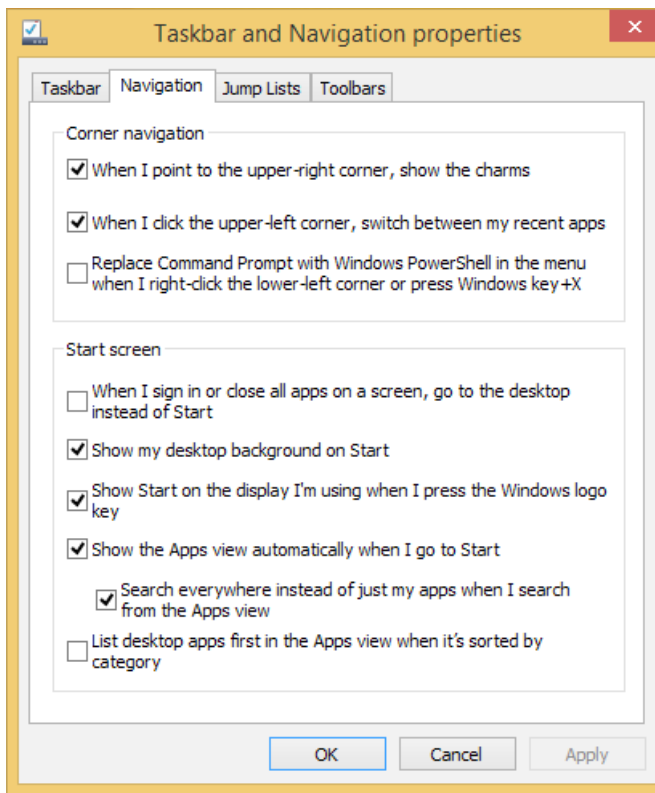

4. Tap/click **Apply** to save the new settings then exit.

Working with Windows® apps



Use your ASUS All-in-One PC's touch screen panel or keyboard to launch and customize your apps.

Launching apps



Tap an app to launch it.



1. Press  twice then use the arrow keys to browse through the apps.
2. Press  to launch your selected app.

Customizing apps

You can move, resize, or unpin apps from the Start screen using the following steps.

Moving apps



Tap and hold the app tile then drag it to a new location.

Resizing apps



Tap and hold the app tile to select and launch its settings bar. Tap  then select an app tile size.

Unpinning apps



Tap and hold the app tile to select and launch its settings bar. Tap  to unpin the selected app.

Closing apps



Swipe down from the top side of the running app then drag it down to the bottom of the screen to close it.



From the running app's screen, press  + .

Accessing All Apps

Aside from the apps already pinned on your Start screen, you can also open other applications through the Apps screen.

NOTE: Actual apps shown onscreen may vary per model. The following screenshot is for reference only.

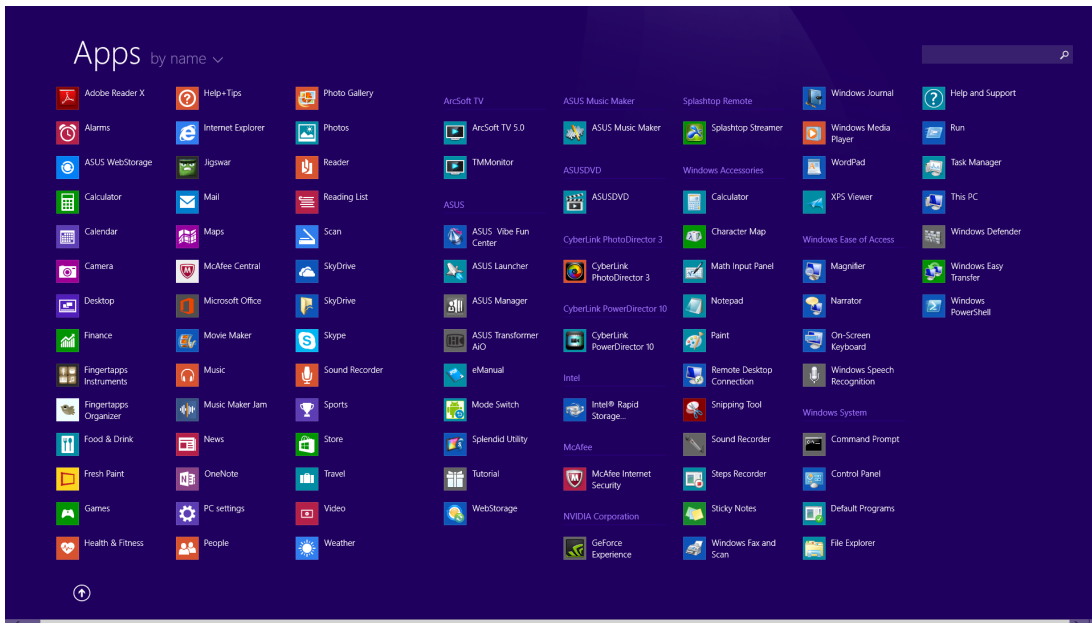

Launching the Apps screen

Launch the Apps screen using your ASUS All-in-One PC's touch screen panel or keyboard.



- Swipe up from the Start screen to launch the Apps screen.
- On the Start screen, click the  button.



From the Start screen, Press  then press .

Pinning more apps on the Start screen

You can pin more apps on the Start screen using your touch screen panel.



1. Launch the Apps screen.
2. Tap and hold the app to launch its settings bar then tap  to pin the selected app to the Start screen.



Charms bar

The charms bar is a toolbar that can be triggered on the right side of your screen. It consists of several charms that allow you to share applications and provide quick access for customizing the settings of your ASUS All-in-One PC.

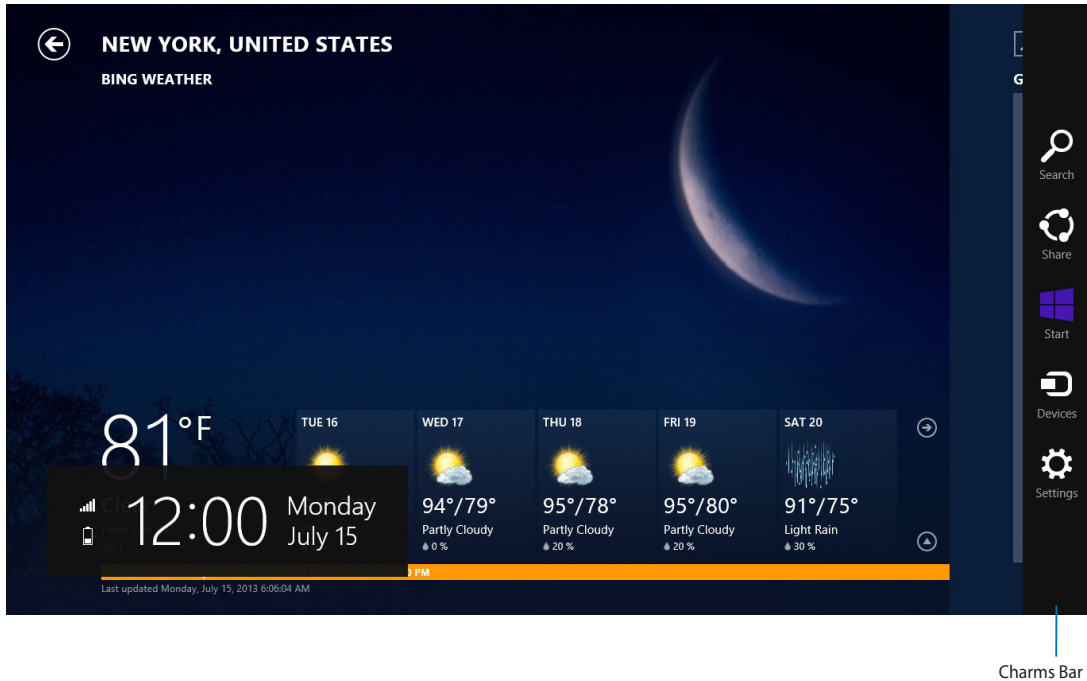

Launching the Charms bar

NOTE: When called out, the charms bar initially appears as a set of white icons. The image above shows how the charms bar looks like once activated.

Use your ASUS All-in-One PC's touch screen panel or keyboard to launch the charms bar.



Swipe the right edge of the screen.



Press  + .

Inside the charms bar



Search

This charm allows you to look for files, applications, or programs in your ASUS All-in-One PC.



Share

This charm allows you to share applications via social networking sites or email.



Start

This charm reverts the display back to the Start screen. From the Start screen, you can also use this to revert back to a recently opened app.



Devices

This charm allows you to access and share files with the devices attached to your ASUS All-in-One PC such as an external display or printer.



Settings

This charm allows you to access the PC settings of your ASUS All-in-One PC.

Snap feature

The Snap feature displays two apps side-by-side, allowing you to work or switch between apps.

IMPORTANT! Ensure that your ASUS All-in-One PC's screen resolution is set to 1366 x 768 pixels or higher before using the Snap feature.

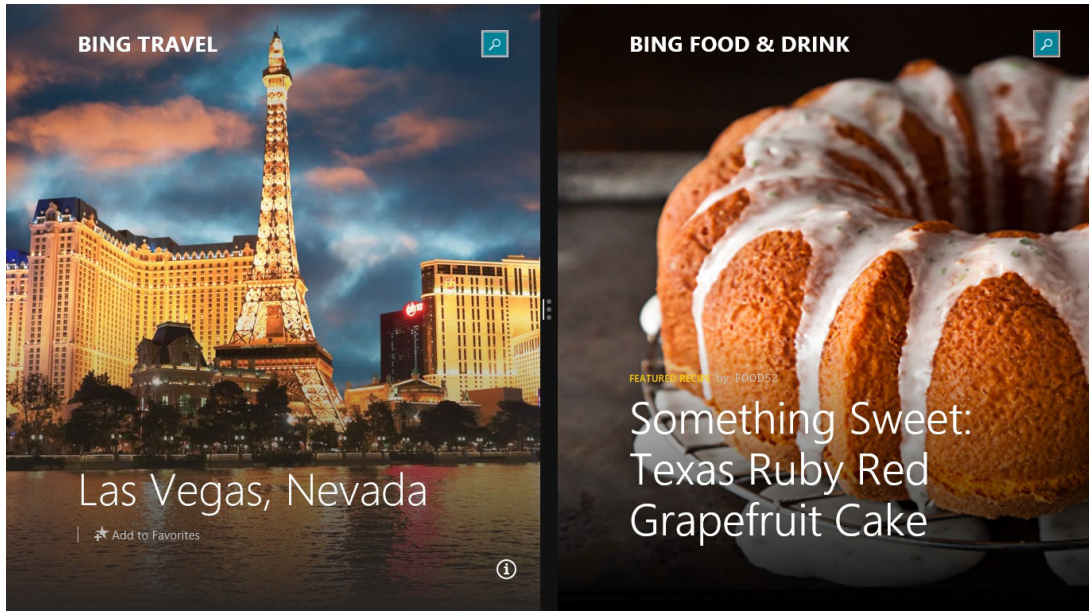

Snap bar

Using Snap

Perform the following steps to activate Snap using your ASUS All-in-One PC's touch screen panel or keyboard.



1. Launch the app you wish to snap.
2. Tap and hold the app then drag it to the left or right side of the display panel.
3. Launch another app.



1. Launch the app you wish to snap.
2. Press  and the left or right arrow key to snap the app to the left or right pane.
3. Launch another app. This app is automatically placed in the empty pane.

Other keyboard shortcuts

Using the keyboard, you can also use the following shortcuts to help you launch applications and navigate Windows® 8.1.



Switches between the Start screen and the last running app



Launches the desktop



Launches the **This PC** window on Desktop mode



Opens the File option from the Search charms



Opens the Share charms



Opens the Settings charms



Opens the Devices charms



Activates the Lock screen



Minimizes all currently active windows







Opens the Project pane



Opens the Everywhere option from the Search charms





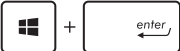

Opens the Run window

-  Opens Ease of Access Center
-  Opens the **Settings** option under the **Search** charms
-  Opens the context menu of the Start button
-  Launches the magnifier icon and zooms in your screen
-  Zooms out your screen
-  Opens the Narrator Settings

Turning off your All-in-One PC

Do either of the following to shut down your All-in-One PC:

-  Tap from  the Charm bar then tap  > **Shut down** to do a normal shutdown.
- From the log-in screen, tap  > **Shut down**.
- If your All-in-One PC is unresponsive, press and hold the power button for at least four (4) seconds until your All-in-One PC turns off.

Putting your ASUS All-in-One PC on sleep mode

Activate sleep mode on your ASUS All-in-One PC or ASUS Portable AiO using either of the following procedures:

- Press the power button once.
- Launch the Desktop mode then press <Alt> + <F4> to launch the Shut Down window. Select **Sleep** from the drop-down list then select **OK**.

Chapter 4: Connecting to the Internet

Access emails, surf the Internet, and share applications via social networking sites on or from your PC using wireless/Wi-Fi or wired connection.

Setting up a Wi-Fi connection in Windows® 8.1

1. Launch the Charm bar from the Start screen or from any application mode.

NOTE: For details, refer to the section **Charm bar** under **Working with Windows® apps**.

2. From the Charm bar, select **Settings** and click the network icon .
3. Select the wireless network that you want to connect to from the list.
4. Click **Connect**.

NOTE: You may be prompted to enter a security key to connect to a secured wireless network.

Configuring your Wi-Fi bandwidth

To configure your Wi-Fi bandwidth:

1. Launch the Desktop mode then right-click on  on the taskbar.
2. Select **Open Network and Sharing Center**.
3. In the Network and Sharing Center window, select the Wi-Fi status beside **Connections**.

- In the Network and Sharing Center window, select the Wi-Fi status beside **Connections**.

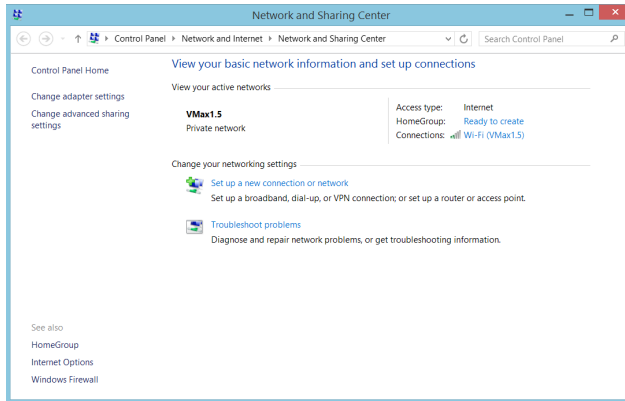

- In the Wi-Fi status window, select **Properties > Configure** to launch your current network adapter's properties.
- In the your current network adapter properties window, select the **Advanced** tab.
- In the Advanced tab, select **Bandwidth Capability** under the **Property** option then select your preferred bandwidth setting by clicking on the drop-down box below **Value**.

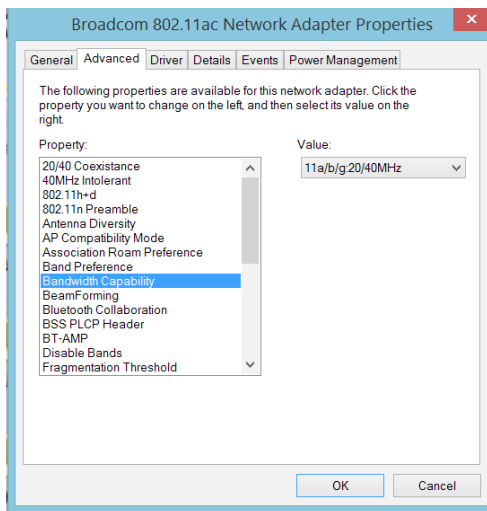

- Click **OK** to save and exit.

Wired connection

1. Use a network (RJ-45) cable to connect your ASUS All-in-One PC to a DSL/cable modem or a local area network (LAN).
2. Turn on your computer.
3. Configure the necessary Internet connection settings.

NOTES:

- For more details, refer to the sections **Configuring a dynamic IP/PPPoE network connection** or **Configuring a static IP network connection**.
 - Contact your Internet Service Provider (ISP) for details or assistance in setting up your Internet connection.
-

Configuring a dynamic IP/PPPoE network connection

To configure a dynamic IP/PPPoE or static IP network connection:

1. From the Start screen, click **Desktop** to launch the Desktop mode.
2. From the Windows® taskbar, right-click the network icon  and click **Open Network and Sharing Center**.
3. From the Open Network and Sharing Center screen, click **Change Adapter settings**.
4. Right-click on your LAN and select **Properties**.
5. Click **Internet Protocol Version 4(TCP/IPv4)** and click **Properties**.
6. Click **Obtain an IP address automatically** and click **OK**.

NOTE: Continue to the next steps if you are using PPPoE connection.

7. Return to the **Network and Sharing Center** and then click **Set up a new connection or network**.
8. Select **Connect to the Internet** and click **Next**.
9. Select **Broadband (PPPoE)** and click **Next**.
10. Enter your **Username**, **Password**, and **Connection name**. Click **Connect**.
11. Click **Close** to finish the configuration.
12. Click the network icon in the taskbar and click the connection you just created.
13. Enter your user name and password. Click **Connect** to connect to the Internet.

Configuring a static IP network connection

To configure a static IP network connection:

1. Repeat steps 1 to 4 of the previous section **Configuring a dynamic IP/PPPoE network connection**.
2. Click **Use the following IP address**.
3. Enter the IP address, Subnet mask and Gateway from your service provider.
4. If needed, enter the preferred DNS Server address and alternative address.
5. When done, click **OK**.

Setting up a Bluetooth Wireless Connection

Bluetooth technology eliminates the need for cables for connecting to Bluetooth-enabled devices. Examples of Bluetooth-enabled devices include Notebook PCs, Desktop PCs, and mobile phones.

NOTE: If your All-in-One PC do not come with a built-in Bluetooth, you need to connect a USB Bluetooth module in order to use Bluetooth.

To add a Bluetooth device in Windows® 8.1:

1. Double-click the Wireless Console icon in the Windows notification area and select the Bluetooth icon.

You can also press <FN>+<F2> until the wireless LAN and Bluetooth are enabled.

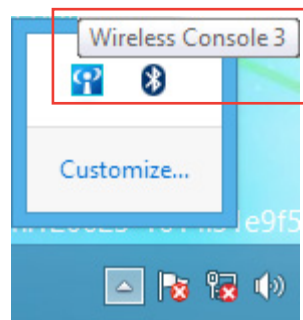

- Click the Bluetooth logo on the System Tray and select **Add a Device** from the context menu.

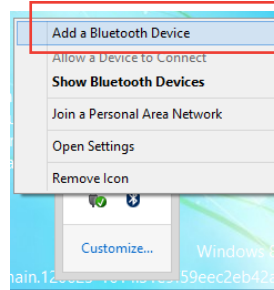

- In the PC settings window, click **Add a device** to look for an available Bluetooth devices.

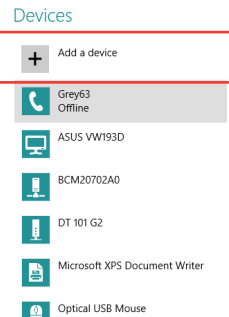

- Select a Bluetooth device from the list.

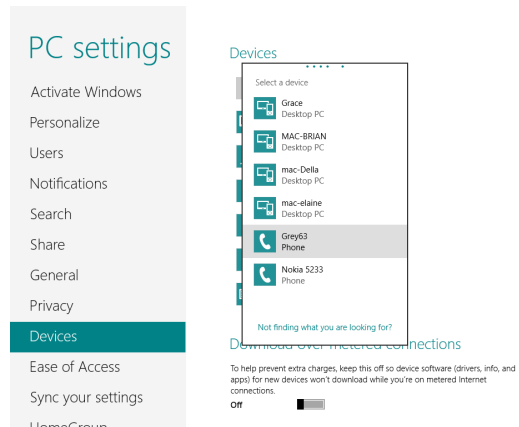

- From the Bluetooth passcode, select **Yes** to confirm and pair the All-in-One PC with the Bluetooth device.

Chapter 5: Recovering your system

Entering the BIOS Setup

BIOS (Basic Input and Output System) stores system hardware settings that are needed for system startup in the PC.

In normal circumstances, the default BIOS settings apply to most conditions to ensure optimal performance. Do not change the default BIOS settings except in the following circumstances:

- An error message appears on the screen during the system bootup and requests you to run the BIOS Setup.
- You have installed a new system component that requires further BIOS settings or update.

WARNING! Inappropriate BIOS settings may result to instability or boot failure. We strongly recommend that you change the BIOS settings only with the help of a trained service personnel.

Quickly enter the BIOS

Windows® 8.1 boot time is quite fast, so we developed these three ways for you to quickly access the BIOS:

- When your All-in-One PC is off, press the power button for at least four (4) seconds to access the BIOS directly.
- Press the power button for at least four (4) seconds to shut down your All-in-One PC, then press the power button again to turn your All-in-One PC back on, and press <F2> during POST.
- When your All-in-One PC is off, disconnect the power cord from your All-in-One PC's power connector. Reconnect the power cord and press the power button to turn on your All-in-One PC. Press <F2> during POST.

NOTE: POST (Power-On Self Test) is a series of software controlled diagnostic tests that run when you turn on your All-in-One PC.

Recovering your system

Resetting your PC

The **Reset your PC** option restores your PC to its factory default settings.

IMPORTANT! Back up all your data before using this option.

To reset your PC:

1. Press <**F9**> during bootup.

IMPORTANT! To go through POST, follow any of the ways described in the section *Quickly enter the BIOS* in Chapter 3.

2. From the screen, click **Troubleshoot**.
3. Select **Reset your PC**.
4. Click **Next**.
5. Select **Only the drive where the Windows is installed**.
6. Select **Just remove my files**.
7. Click **Reset**.

Recovering from a system image file

You can create a USB recovery drive and use this to recover your PC's settings.

Creating a USB recovery drive

WARNING! All files on your USB storage device will be permanently deleted during the process. Before you proceed, ensure that you back up all your important data.

To create a USB recovery drive:

1. Launch the Control Panel from the All Apps screen.

NOTE: For details, refer to *Launching the All Apps screen* under *Working with Windows® apps*.

2. From the Control Panel's System and Security, click **Find and fix problems**.
3. Click **Recovery** > **Create a recovery drive**.
4. Click **Next**.
5. Select the USB storage device where you want to copy the recovery files.
6. Click **Next**.
7. Click **Create**. Wait for a while for the process to complete.
8. When the process is completed, click **Finish**.

Removing everything and reinstalling Windows

Restoring your PC to its original factory settings can be done using the Remove everything and reinstall option in PC Settings. Refer to the steps below to use this option.

IMPORTANT! Back up all your data before using this option.

NOTE: This process may take a while to complete.

1. Launch the Charms bar.
2. Click **Settings > Change PC Settings > General**.
3. Scroll down to view the Remove everything and reinstall Windows option. Under this option, click **Get Started**.
4. Follow the onscreen instructions to complete the reinstallation and reset process.

Appendices

Notices

REACH

Complying with the REACH (Registration, Evaluation, Authorization, and Restriction of Chemicals) regulatory framework, we publish the chemical substances in our products at ASUS REACH website at <http://csr.asus.com/english/REACH.htm>

ASUS Recycling/Takeback Services

ASUS recycling and takeback programs come from our commitment to the highest standards for protecting our environment. We believe in providing solutions for you to be able to responsibly recycle our products, batteries, other components, as well as the packaging materials. Please go to <http://csr.asus.com/english/Takeback.htm> for the detailed recycling information in different regions.

COATING NOTICE

IMPORTANT! To provide electrical insulation and maintain electrical safety, a coating is applied to insulate the device except on the areas where the I/O ports are located.

Federal Communications Commission Statement

This device complies with Part 15 of the FCC Rules. Operation is subject to the following two conditions:

- This device may not cause harmful interference, and
- This device must accept any interference received including interference that may cause undesired operation.

This e-uipment has been tested and found to comply with the limits for a Class B digital device, pursuant to Part 15 of the FCC Rules. These limits are designed to provide reasonable protection against harmful interference in a residential installation. This e-uipment generates, uses and can radiate radio frequency energy and, if not installed and used in accordance with manufacturer's instructions, may cause harmful interference to radio communications. However, there is no guarantee that interference will not occur in a particular installation. If this e-uipment does cause harmful interference to radio or television reception, which can be determined by turning the e-uipment off and on, the user is encouraged to try to correct the interference by one or more of the following measures:

- Reorient or relocate the receiving antenna.
- Increase the separation between the e-uipment and receiver.

- Connect the e-uipment to an outlet on a circuit different from that to which the receiver is connected.
- Consult the dealer or an experienced radio/TV technician for help.

IMPORTANT! Outdoor operations in the 5.15~5.25GHz band is prohibited. This device has no Ad-hoc capability for 5250~5350 and 5470~5725 MHz.

CAUTION: Any changes or modifications not expressly approved by the guarantee of this device could void the user's authority to operate the e-uipment.

RF exposure warning

This e-uipment must be installed and operated in accordance with provided instructions and the antenna(s) used for this transmitter must be installed to provide a separation distance of at least 20 cm from all persons and must not be co-located or operating in conjunction with any other antenna or transmitter. End-users and installers must be provided with antenna installation instructions and transmitter operating conditions for satisfying RF exposure compliance.

Canadian Department of Communications Statement

This digital apparatus does not exceed the Class B limits for radio noise emissions from digital apparatus set out in the Radio Interference Regulations of the Canadian Department of Communications.

This class B digital apparatus complies with Canadian ICES-003.

IC Radiation Exposure Statement for Canada

This e-uipment complies with IC radiation exposure limits set forth for an uncontrolled environment. To maintain compliance with IC RF exposure compliance re-uirements, please avoid direct contact to the transmitting antenna during transmitting. End users must follow the specific operating instructions for satisfying RF exposure compliance.

Operation is subject to the following two conditions:

- This device may not cause interference and
- This device must accept any interference, including interference that may cause undesired operation of the device.

Canada, Industry Canada (IC) Notices

This Class B digital apparatus complies with Canadian ICES-003 and RSS-210.

Operation is subject to the following two conditions: (1) this device may not cause interference, and (2) this device must accept any interference, including interference that may cause undesired operation of the device.

Canada, avis d'Industry Canada (IC)

Cet appareil numérique de classe B est conforme aux normes canadiennes ICES-003 et RSS-210.

Son fonctionnement est soumis aux deux conditions suivantes: (1) cet appareil ne doit pas causer d'interférence et (2) cet appareil doit accepter toute interférence, notamment les interférences qui peuvent affecter son fonctionnement.

Declaration of Conformity (R&TTE directive 1999/5/EC)

The following items were completed and are considered relevant and sufficient:

- Essential requirements as in [Article 3]
- Protection requirements for health and safety as in [Article 3.1a]
- Testing for electric safety according to [EN 60950]
- Protection requirements for electromagnetic compatibility in [Article 3.1b]
- Testing for electromagnetic compatibility in [EN 301 489-1] & [EN 301 489-17]
- Effective use of the radio spectrum as in [Article 3.2]
- Radio test suites according to [EN 300 328-2]

CE Mark Warning

This is a Class B product, in a domestic environment, this product may cause radio interference, in which case the user may be required to take adequate measures.



CE marking for devices without wireless LAN/Bluetooth

The shipped version of this device complies with the requirements of the EEC directives 2004/108/EC "Electromagnetic compatibility" and 2006/95/EC "Low voltage directive".



CE marking for devices with wireless LAN/ Bluetooth

This e-uipment complies with the re-uirements of Directive 1999/5/EC of the European Parliament and Commission from 9 March, 1999 governing Radio and Telecommunications E-uipment and mutual recognition of conformity.

ⓘ is for class II device.

Wireless Operation Channel for Different Domains

N. America	2.412-2.462 GHz	Ch01 through CH11
Japan	2.412-2.484 GHz	Ch01 through Ch14
Europe ETSI	2.412-2.472 GHz	Ch01 through Ch13

NO DISASSEMBLY

The warranty does not apply to the products that have been disassembled by users

Lithium-Ion Battery Warning

CAUTION: Danger of explosion if battery is incorrectly replaced. Replace only with the same or e-uivalent type recommended by the manufacturer. Dispose of used batteries according to the manufacturer's instructions.

No Exposure to Li-uids

DO NOT expose to or use near li-uids, rain, or moisture. This product is not waterproof or oil-proof.



This symbol of the crossed out wheeled bin indicates that the product (electrical, electronic e-uipment, and mercury-containing button cell battery) should not be placed in municipal waste. Check local regulations for disposal of electronic products.



DO NOT throw the battery in municipal waste. The symbol of the crossed out wheeled bin indicates that the battery should not be placed in municipal waste.

Global Environmental Regulation Compliance and Declaration

ASUS follows the green design concept to design and manufacture our products, and makes sure that each stage of the product life cycle of ASUS product is in line with global environmental regulations. In addition, ASUS disclose the relevant information based on regulation re•uirements.

Please refer to <http://csr.asus.com/english/Compliance.htm> for information disclosure based on regulation re•uirements ASUS is complied with:

Japan JIS-C-0950 Material Declarations

EU REACH SVHC

Korea RoHS

Swiss Energy Laws

ENERGY STAR complied product



ENERGY STAR is a joint program of the U.S. Environmental Protection Agency and the U.S. Department of Energy helping us all save money and protect the environment through energy efficient products and practices.

All ASUS products with the ENERGY STAR logo comply with the ENERGY STAR standard, and the power management feature is enabled by default. The monitor and computer are automatically set to sleep after 10 and 30 minutes of user inactivity. To wake your computer, click the mouse or press any key on the keyboard.

Please visit <http://www.energy.gov/powermanagement> for detail information on power management and its benefits to the environment. In addition, please visit <http://www.energystar.gov> for detail information on the ENERGY STAR joint program.

NOTE: ENERGY STAR is NOT supported on Freedos and Linux-based products.

Manufacturer	ASUSTeK Computer Inc.	
	Tel:	+886-2-2894-3447
	Address:	4F, No. 150, LI-TE RD., PEITOU, TAIPEI 112, TAIWAN
Authorised representative in Europe	ASUSTeK Computer GmbH	
	Address:	HARKORT STR. 21-23, 40880 RATINGEN, GERMANY